

\$ SHRIDHAN[®]
Automate your Field



**FLOAT OPERATED
LEVEL TRANSMITTERS**



1. FLOAT OPERATED LEVEL TRANSMITTERS

2. FLX SERIES - REED CHAIN LEVEL TRANSMITTER

2.1 Construction & Operation	...01
2.2 General specifications	...01
2.3 Ordering information	...02
2.4 Installation Options	...03
2.5 Drawings with Specification	...04

3 MLX Series - Magnetostrictive Level Transmitter

3.1 Applications	..20
3.2 Operating Principle.	..20



ISO - 9001 QMS



2014/34/EU



Conformité Européenne
2460



ABS - Type Approved Product



Pressure Equipment Directive
2014/68/EU

1. FLOAT OPERATED LEVEL TRANSMITTERS

It is a simple and reliable sensor for continuous level indication and control of any liquid, chemically compatible with the (sensor) material, unaffected by electrical conductivity, temperature, pressure or viscosity. The float is designed for variety of liquids and its unique self cleaning construction is well suited for even sticky or dirty environments with no float hang-ups.

FEATURES

- Continuous 'Float Type' Analog Sensor, resistive to most liquids
- Pre calibrated at factory - No Field Calibration required
- 4-20 mA, 2 wire processed output signal
- High Resolution & Repeatability
- Liquid level or liquid / liquid interface detection
- Multiple alarm relays adjustable option
- Customized lengths up to 4 meters
- Intrinsically safe option available
- RS-232, RS-485 compatible



2. REED CHAIN LEVEL TRANSMITTERS - FLX

2.1 CONSTRUCTION & OPERATION

It consists of a float & guide stem assembly in non-magnetic material to achieve undisturbed flux. A chain of closely spaced glass encapsulated reed switches & resistors are placed inside the guide tube. During rise and fall of liquid level, the float moves & actuates a series of reed switches in the chain, through a magnet system within it and develops a proportional resistance. The operation is similar to a sliding resistance potentiometer. The sensed resistance is fed to the transmitter located in the enclosure for conversion to a signal of 4-20 mA.

2.2 SPECIFICATIONS

Measuring Range	: *GSL - (Top *DB + Bottom *DB)
Span (L)	: Min. 300 mm (*GSL 375 mm) Max. 3750 mm (*GSL 4000 mm)
Resolution / Accuracy	: Standard ± 10 mm / 1 mm High ± 5 mm / 0.5 mm
Installation	: Top
Enclosure	: Cast Al weather proof IP-65 or Ex proof Gr IIA & IIB or IIC
Conduit Connection	: Brass, 3/4" ET or 1/2" NPT
Wetted Parts	: SS304, SS316, PP/PVDF
Float	: $\varnothing 41$ mm, $\varnothing 45$ mm, $\varnothing 52$ mm, $\varnothing 63$ mm in SS316 & $\varnothing 46$ mm in PP/PVDF
Process Connection	: 2 1/2" or 3" or 4" NB Flanged in SS/PP to BS (option ANSI or DIN std) 2" BSP in SS/PP Threaded
Output	: DC 4-20 mA (isolated) or 1 to 5 VDC (Optional) / HART Protocol
Wiring System	: 2 Wire
Max. Load	: 400 Ohms
Max. Temperature	: 120°C (Metallic MOC)
Max. Test pressure	: 10Kg/cm ² (Metallic MOC)
Special feature	: Intrinsically safe to Ex ib Gr IIA-IIB

* DB - Dead Band, * GSL - Guided Stem Length

2.3 ORDERING INFORMATION FOR MAGNETIC FLOAT OPERATED LEVEL TRANSMITTERS

SPECIFY PART NO. → FLX **1** **2** **3** **4** **5** **6**

FLX

Example FLX A A S1 E 1 3

1 ENCLOSURE

- A. Cast Al. Weather Proof IP-65
- B. Cast Al. Ex-Proof IP-65, Gr IIA, IIB or IIC
- C. Terminal Box
- D. Cable (Resistance Outputs Only)
- E. Others.

4 OUTPUT

- A. 4 - 20 mA (Galvanically Isolated)
- B. 4 - 20 mA, HART Protocol
- C. 4 - 20 mA, RS-232 / RS-485
- D. 1 - 5 V DC
- E. 2 - 10 V DC

2 PROCESS CONNECTION

- | | |
|-------------------|-----------|
| Flanged | Threaded |
| A. 2" 150 # ANSI | 1. 2" BSP |
| B. 2½" 150 # ANSI | 2. 3" BSP |
| C. 3" 150 # ANSI | 3. Others |
| D. Others | |

5 MOUNTING

- 1. Top / Internal Mounting
- 2. Side / Chamber Mounting

3 FLOAT

TYPE	Material	Float	Dia Stem
S1.	SS316	52 mm	12.7 mm
S2.	SS316	63 mm	16 mm
S3.	PP	46 mm	16 mm
S4.	Specify	Others	

6 CONFIGURATION

- 1. Isolated output without controller
- 2. Isolated output with controller
- 3. Foundation Fieldbus™
- 4. Tank gauging software.

EXTERNAL CHAMBER MOUNTING FOR LEVEL TRANSMITTERS

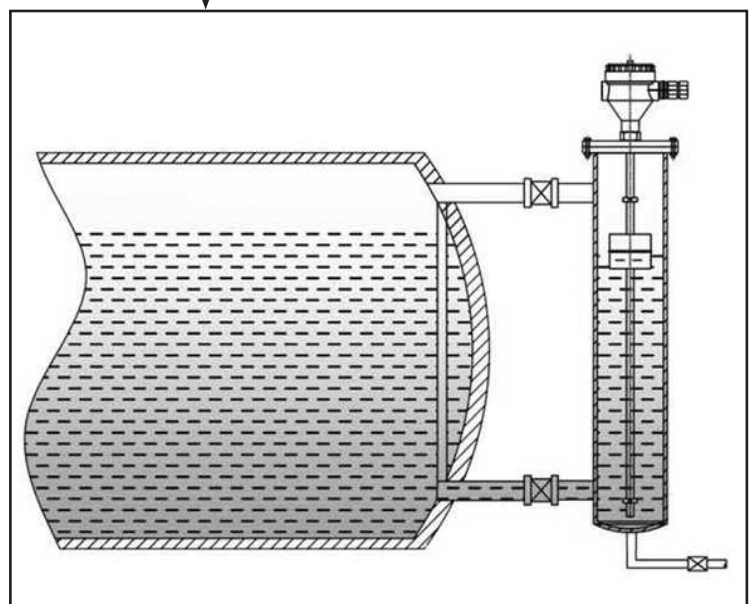
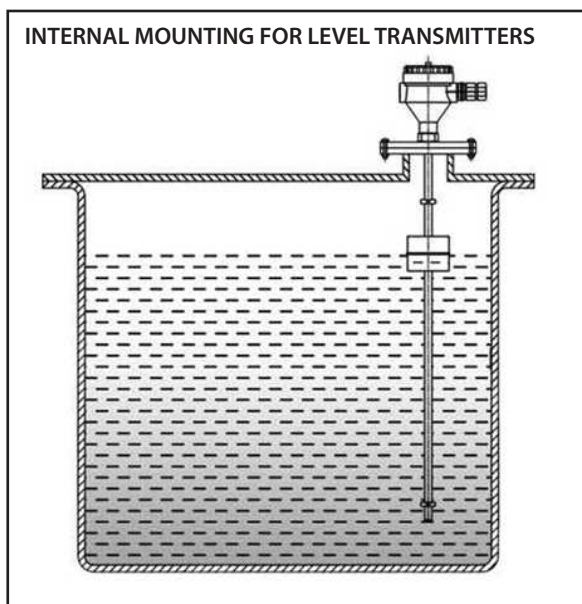

2.4 INSTALLATION OPTIONS

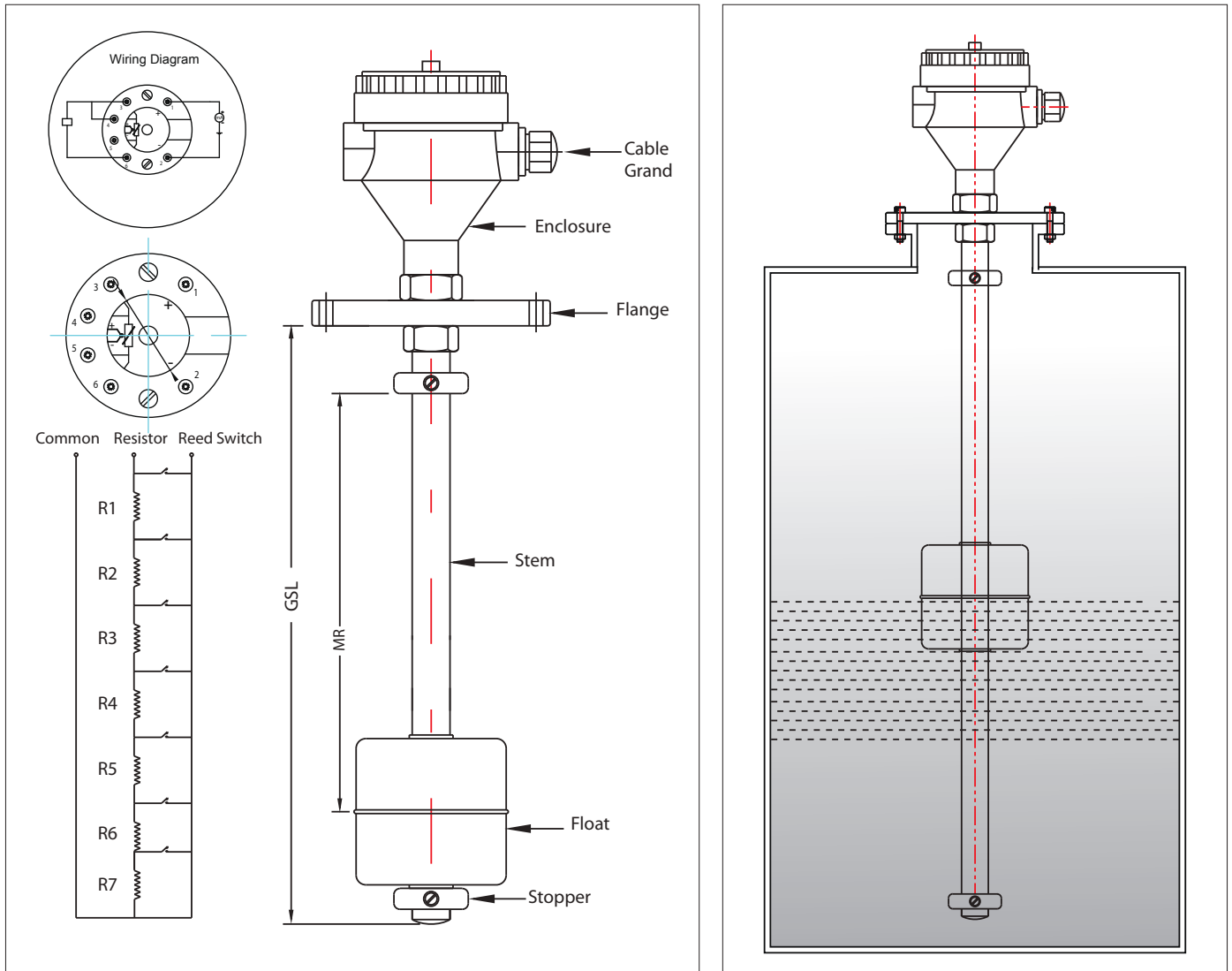

LEVEL CONTROLLER - DLC1001(OPTION AVAILABLE ON REQUEST)



Type	FLX B-A-S1-D-1-1	FLX A-A-S1-D-1-1
Material Type	304 / 316 / 316L	304/316/316L
Enclosure	Cast Al, Ex-Proof Gr IIA, IIB or IIC	Cast Al, Weather Proof
Process Connection	2" 150 # ANSI Flange	2" 150 # ANSI Flange
Guide Stem	∅ 12.7mm	∅ 12.7 mm
Sensor Length	MR = Min 300mm to 3750 mm * GSL= Min 375mm to 4000 mm *	MR = Min 300mm to 3750 mm * GSL= Min 375mm to 4000 mm *
Float	∅ 52 mm	∅ 52 mm
Specific Gravity	0.7	0.7
Design Pressure	10 Kg/cm ²	10 Kg/cm ²
Design Temperature	120°C	120°C
Output	1-5V DC	1-5V DC
Ingress protection Class	IP 65 (Flame Proof)	IP 65 (Weather Proof)
Mounting Position	Vertical	Vertical

Approval certificate

ATEX/CE/ABS

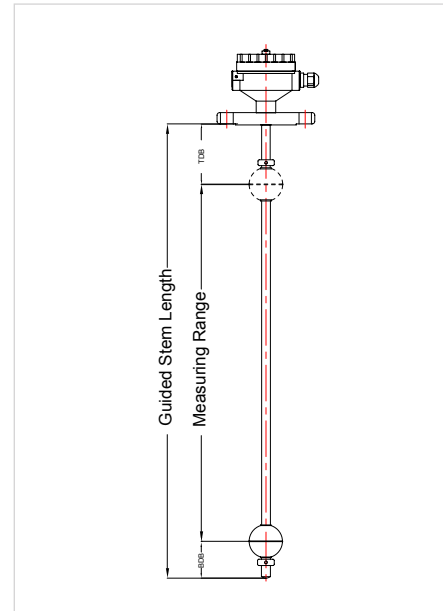
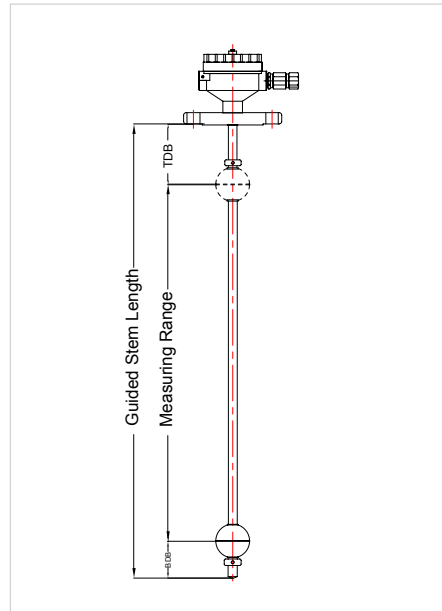

Type	FLX B-B-S1-A-1-1	FLX A-B-S1-A-1-1
Material Type	304 / 316 / 316L	304/316/316L
Enclosure	Cast Al, Ex-Proof Gr IIA, IIB or IIC	Cast Al, Weather Proof
Process Connection	2½" 150 # ANSI Flange	2½" 150 # ANSI Flange
Guide Stem	∅ 12.7 mm	∅ 12.7 mm
Sensor Length	MR = Min 300mm to 3750 mm * GSL= Min 375mm to 4000 mm *	MR = Min 300mm to 3750 mm * GSL= Min 375mm to 4000 mm *
Float	∅ 52 mm	∅ 52 mm
Specific Gravity	0.7	0.7
Design Pressure	10 Kg/cm ²	10 Kg/cm ²
Design Temperature	120°C	120°C
Output	4-20 mA	4-20 mA
Ingress protection Class	IP 65 (Flame Proof)	IP 65 (Weather Proof)
Mounting Position	Vertical	Vertical

Approval certificate

ATEX/CE/ABS

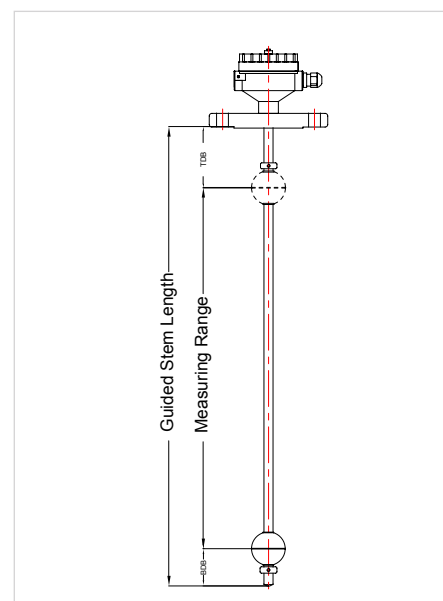
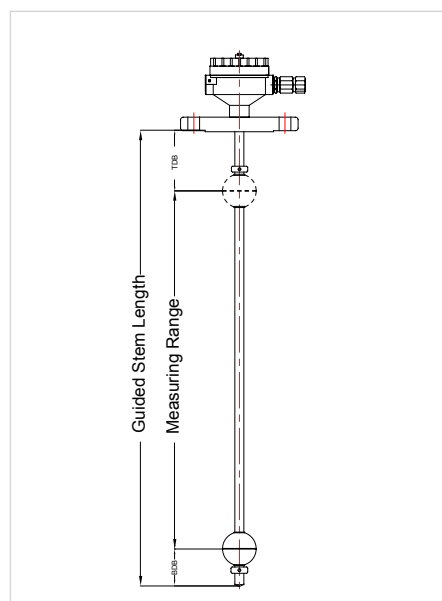

Type	FLX B-C S1-A-1-1	FLX A-C-S1-A-1-1
Material Type	304 / 316 / 316L	304/316/316L
Enclosure	Cast Al, Ex-Proof Gr IIA, IIB or IIC	Cast Al, Weather Proof
Process Connection	3" 150 # ANSI Flange	3" 150 # ANSI Flange
Guide Stem	∅ 12.7 mm	∅ 12.7 mm
Sensor Length	MR = Min 300mm to 3750 mm * GSL= Min 375mm to 4000 mm *	MR = Min 300mm to 3750 mm * GSL= Min 375mm to 4000 mm *
Float	∅ 52 mm	∅ 52 mm
Specific Gravity	0.7	0.7
Design Pressure	10 Kg/cm ²	10 Kg/cm ²
Design Temperature	150°C	150°C
Output	1-5V DC	1-5V DC
Ingress protection Class	IP 65 (Flame Proof)	IP 65 (Weather Proof)
Mounting Position	Vertical	Vertical

Approval certificate

ATEX/CE/ABS

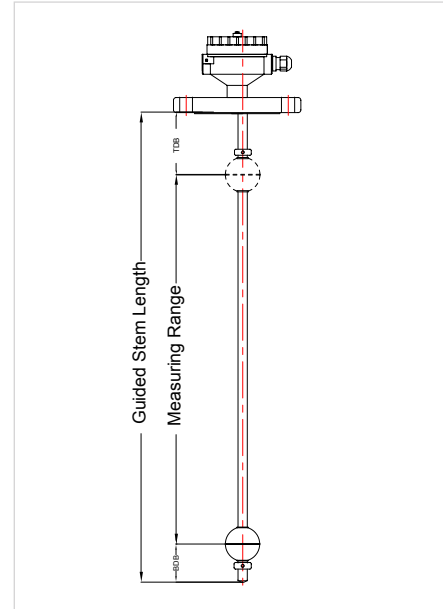
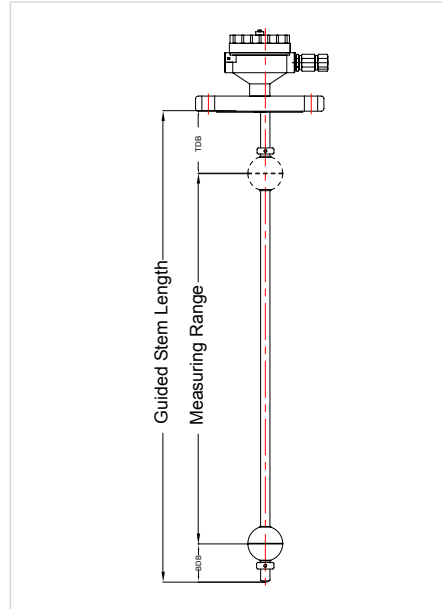

Type	FLX B-D-S1-D-1-1	FLX A-D-S1-D-1-1
Material Type	304 / 316 / 316L	304/316/316L
Enclosure	Cast Al, Ex-Proof Gr IIA, IIB or IIC	Cast Al, Weather Proof
Process Connection	4" 150 # ANSI Flange	4" 150 # ANSI Flange
Guide Stem	∅ 12.7 mm	∅ 12.7 mm
Sensor Length	MR = Min 300mm to 3750 mm * GSL= Min 375mm to 4000 mm *	MR = Min 300mm to 3750 mm * GSL= Min 375mm to 4000 mm *
Float	∅ 52 mm	∅ 52 mm
Specific Gravity	0.7	0.7
Design Pressure	10 Kg/cm ²	10 Kg/cm ²
Design Temperature	120°C	120°C
Output	1-5V DC	1-5V DC
Ingress protection Class	IP 65 (Flame Proof)	IP 65 (Weather Proof)
Mounting Position	Vertical	Vertical

Approval certificate

ATEX/CE/ABS

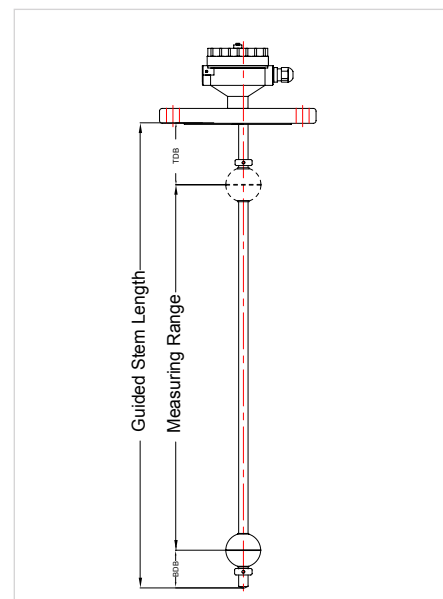
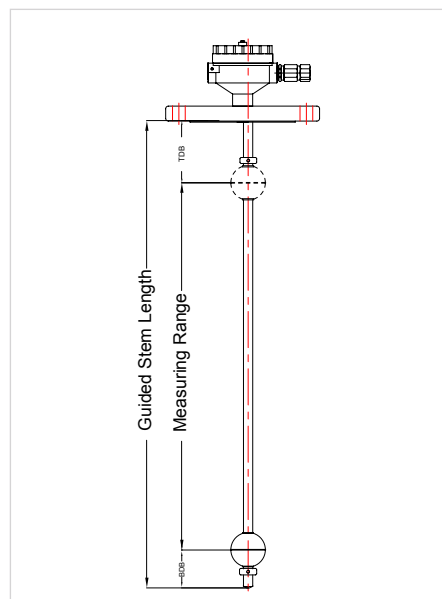

Type	FLX B-D-S1-A-1-1	FLX A-D-S1-A-1-1
Material Type	304 / 316 / 316L	304/316/316L
Enclosure	Cast Al, Ex-Proof Gr IIA, IIB or IIC	Cast Al, Weather Proof
Process Connection	2" Table 'E'	2" Table 'E'
Guide Stem	∅ 12.7 mm	∅ 12.7 mm
Sensor Length	MR = Min 300mm to 3750 mm * GSL= Min 375mm to 4000 mm *	MR = Min 300mm to 3750 mm * GSL= Min 375mm to 4000 mm *
Float	∅ 52 mm	∅ 52 mm
Specific Gravity	0.7	0.7
Design Pressure	10 Kg/cm ²	10 Kg/cm ²
Design Temperature	120°C	120°C
Output	4-20 mA	4-20 mA
Ingress protection Class	IP 65 (Flame Proof)	IP 65 (Weather Proof)
Mounting Position	Vertical	Vertical

Approval certificate

ATEX/CE/ABS

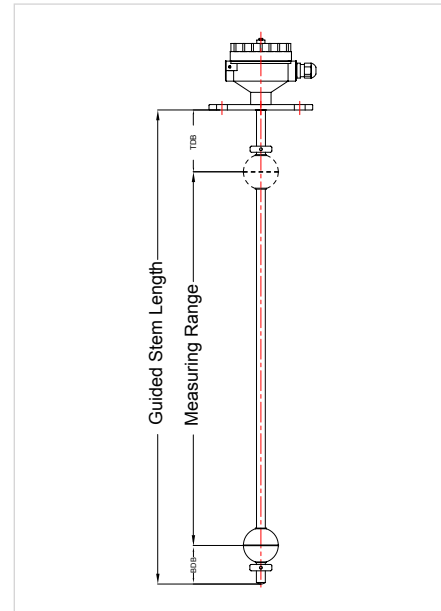
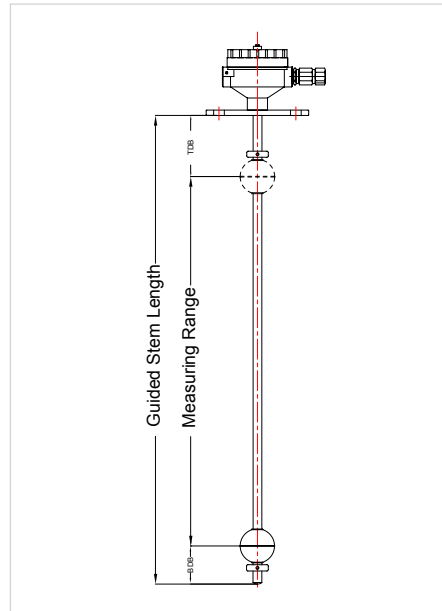

Type	FLX B-D-S1-D-1-1	FLX A-D-S1-D-1-1
Material Type	304 / 316 / 316L	304/316/316L
Enclosure	Cast Al, Ex-Proof Gr IIA, IIB or IIC	Cast Al, Weather Proof
Process Connection	2½" Table 'E'	2½" Table 'E'
Guide Stem	∅ 12.7 mm	∅ 12.7 mm
Sensor Length	MR = Min 300mm to 3750 mm * GSL= Min 375mm to 4000 mm *	MR = Min 300mm to 3750 mm * GSL= Min 375mm to 4000 mm *
Float	∅ 52 mm	∅ 52 mm
Specific Gravity	0.7	0.7
Design Pressure	10 Kg/cm ²	10 Kg/cm ²
Design Temperature	120°C	120°C
Output	1-5V DC	1-5V DC
Ingress protection Class	IP 65 (Flame Proof)	IP 65 (Weather Proof)
Mounting Position	Vertical	Vertical

Approval certificate

ATEX/CE/ABS

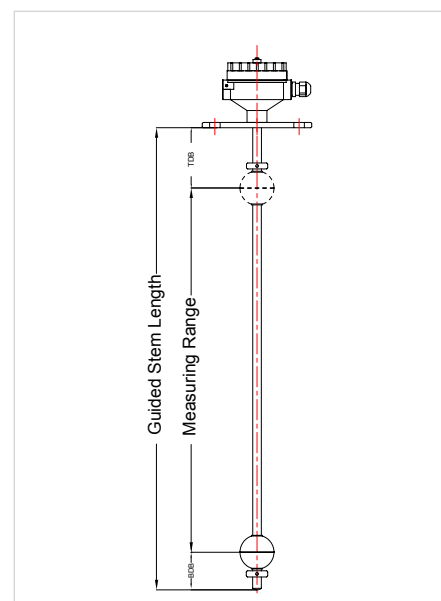
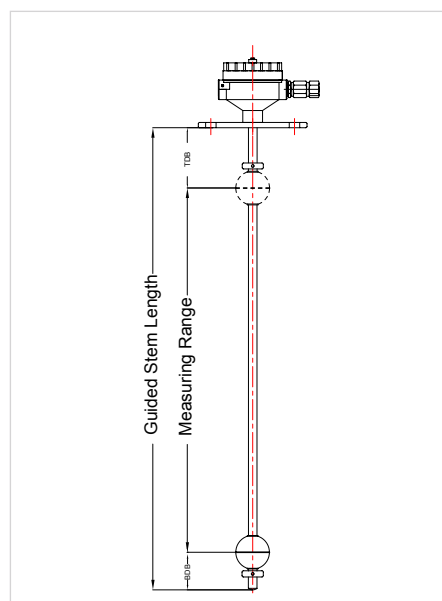

Type	FLX B-D-S1-A-1-1	FLX A-D-S1-A-1-1
Material Type	304 / 316 / 316L	304/316/316L
Enclosure	Cast Al, Ex-Proof Gr IIA, IIB or IIC	Cast Al, Weather Proof
Process Connection	3" Table 'E'	3" Table 'E'
Guide Stem	∅ 12.7 mm	∅ 12.7 mm
Sensor Length	MR = Min 300mm to 3750 mm * GSL= Min 375mm to 4000 mm *	MR = Min 300mm to 3750 mm * GSL= Min 375mm to 4000 mm *
Float	∅ 52 mm	∅ 52 mm
Specific Gravity	0.7	0.7
Design Pressure	10 Kg/cm ²	10 Kg/cm ²
Design Temperature	120°C	120°C
Output	4-20 mA	4-20 mA
Ingress protection Class	IP 65 (Flame Proof)	IP 65 (Weather Proof)
Mounting Position	Vertical	Vertical

Approval certificate
ATEX/CE/ABS

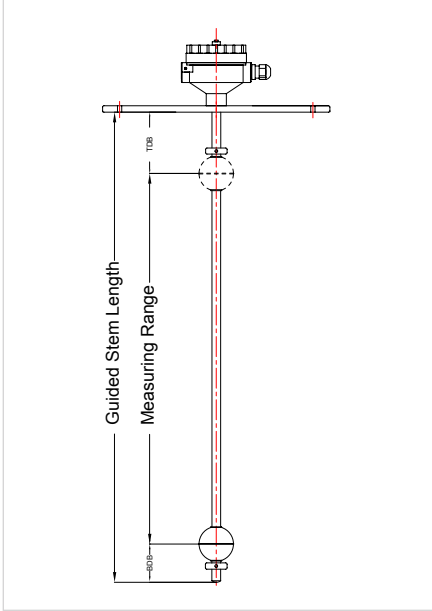
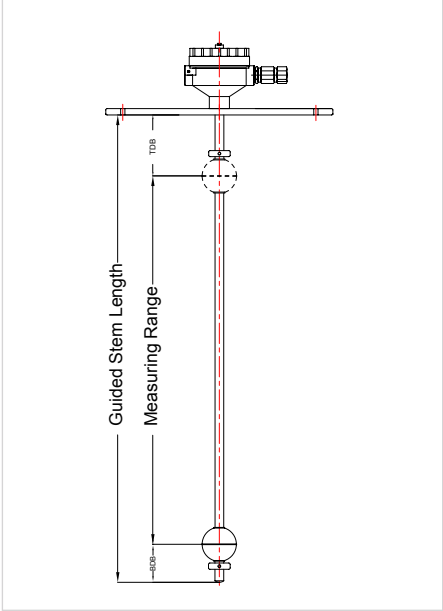

Type	FLX B-A-S2-A-1-1	FLX A-A-S2-A-1-1
Material Type	304 / 316 / 316L	304/316/316L
Enclosure	Cast Al, Ex-Proof Gr IIA, IIB or IIC	Cast Al, Weather Proof
Process Connection	2" 150 # ANSI Flange	2" 150 # ANSI Flange
Guide Stem	∅ 16 mm	∅ 16 mm
Sensor Length	MR = Min 300mm to 3750 mm * GSL= Min 375mm to 4000 mm *	MR = Min 300mm to 3750 mm * GSL= Min 375mm to 4000 mm *
Float	∅ 63 mm	∅ 63 mm
Specific Gravity	0.7	0.7
Design Pressure	10 Kg/cm ²	10 Kg/cm ²
Design Temperature	120°C	120°C
Output	4-20 mA	4-20 mA
Ingress protection Class	IP 65 (Flame Proof)	IP 65 (Weather Proof)
Mounting Position	Vertical	Vertical

Approval certificate

ATEX/CE/ABS

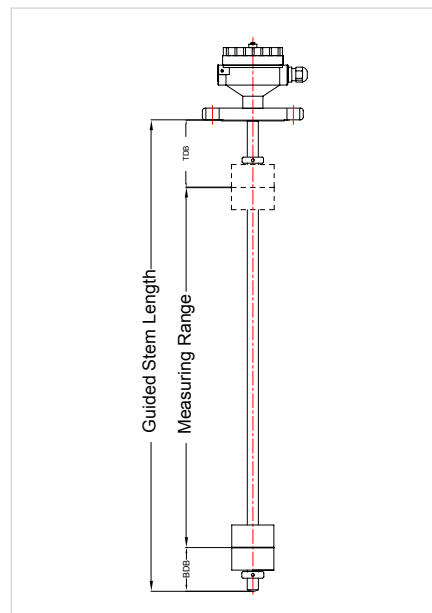
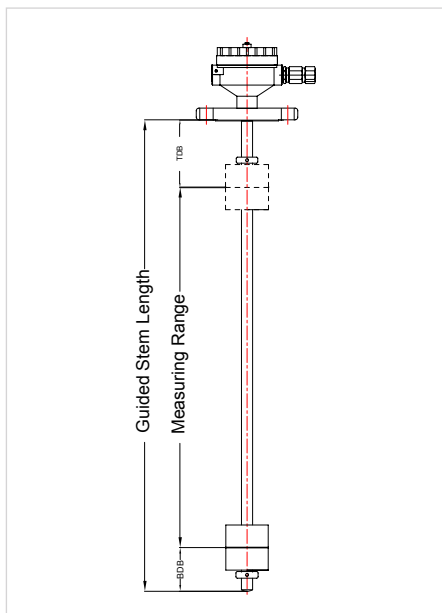

Type	FLX B-B-S2-D-1-1	FLX A-B-S2-D-1-1
Material Type	304 / 316 / 316L	304/316/316L
Enclosure	Cast Al, Ex-Proof Gr IIA, IIB or IIC	Cast Al, Weather Proof
Process Connection	2½" 150 # ANSI Flange	2½" 150 # ANSI Flange
Guide Stem	∅ 16 mm	∅ 16 mm
Sensor Length	MR = Min 300mm to 3750 mm * GSL= Min 375mm to 4000 mm *	MR = Min 300mm to 3750 mm * GSL= Min 375mm to 4000 mm *
Float	∅ 63 mm	∅ 63 mm
Specific Gravity	0.7	0.7
Design Pressure	10 Kg/cm ²	10 Kg/cm ²
Design Temperature	120°C	120°C
Output	1-5V DC	1-5V DC
Ingress protection Class	IP 65 (Flame Proof)	IP 65 (Weather Proof)
Mounting Position	Vertical	Vertical

Approval certificate

ATEX/CE/ABS

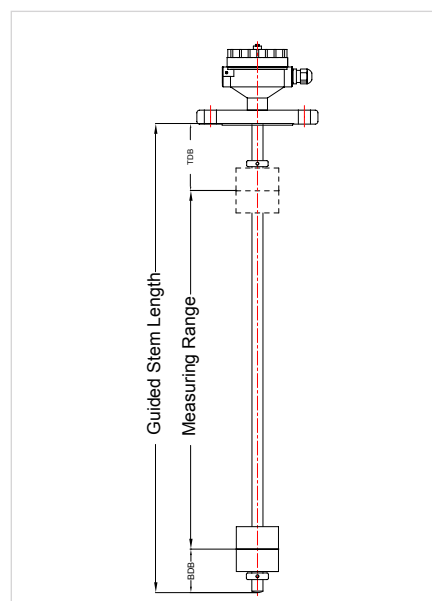
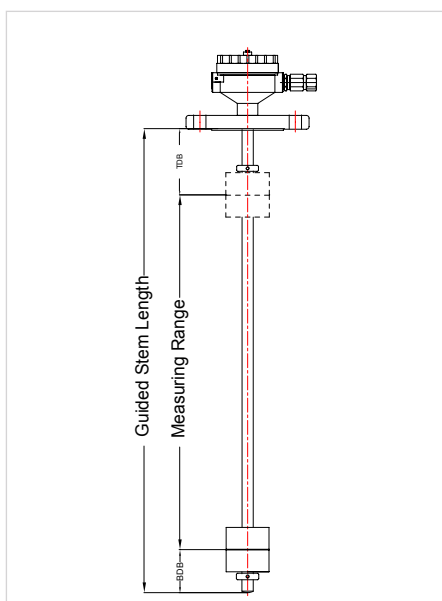

Type	FLX B-C-S2-A-1-1	FLX A-C-S2-A-1-1
Material Type	304 / 316 / 316L	304/316/316L
Enclosure	Cast Al, Ex-Proof Gr IIA, IIB or IIC	Cast Al, Weather Proof
Process Connection	3" 150 # ANSI Flange	3" 150 # ANSI Flange
Guide Stem	∅ 16 mm	∅ 16 mm
Sensor Length	MR = Min 300mm to 3750 mm * GSL= Min 375mm to 4000 mm *	MR = Min 300mm to 3750 mm * GSL= Min 375mm to 4000 mm *
Float	∅ 63 mm	∅ 63 mm
Specific Gravity	0.7	0.7
Design Pressure	10 Kg/cm ²	10 Kg/cm ²
Design Temperature	120°C	120°C
Output	4-20 mA	4-20 mA
Ingress protection Class	IP 65 (Flame Proof)	IP 65 (Weather Proof)
Mounting Position	Vertical	Vertical

Optional Control Unit
Approval certificate
ATEX/CE/ABS

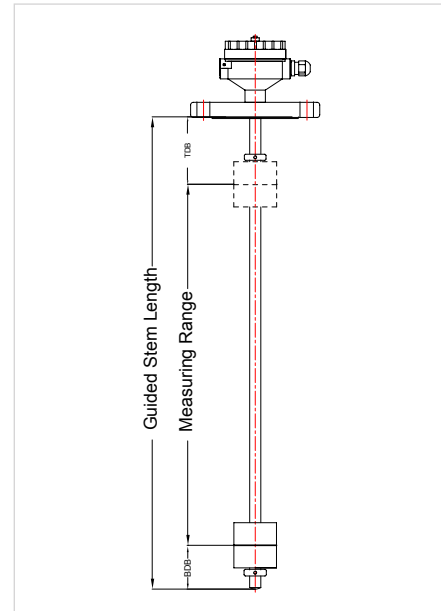
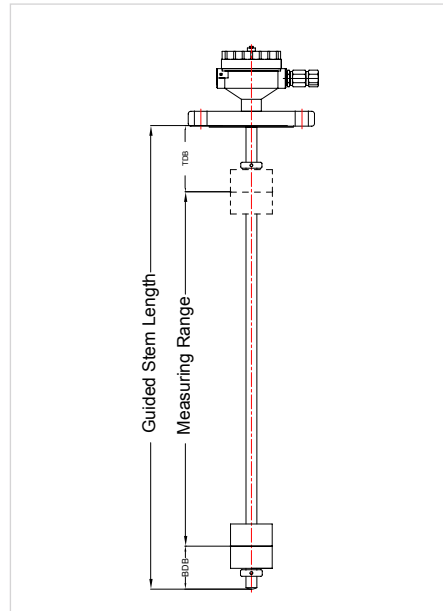

Type	FLX B-D-S2-D-1-1	FLX A-D-S2-D-1-1
Material Type	304 / 316 / 316L	304/316/316L
Enclosure	Cast Al, Ex-Proof Gr IIA, IIB or IIC	Cast Al, Weather Proof
Process Connection	4" 150 # ANSI Flange	4" 150 # ANSI Flange
Guide Stem	∅ 16 mm	∅ 16 mm
Sensor Length	MR = Min 300mm to 3750 mm * GSL= Min 375mm to 4000 mm *	MR = Min 300mm to 3750 mm * GSL= Min 375mm to 4000 mm *
Float	∅ 63 mm	∅ 63 mm
Specific Gravity	0.7	0.7
Design Pressure	10 Kg/cm ²	10 Kg/cm ²
Design Temperature	120°C	120°C
Output	1-5V DC	1-5V DC
Ingress protection Class	IP 65 (Flame Proof)	IP 65 (Weather Proof)
Mounting Position	Vertical	Vertical

Approval certificate
ATEX/CE/ABS

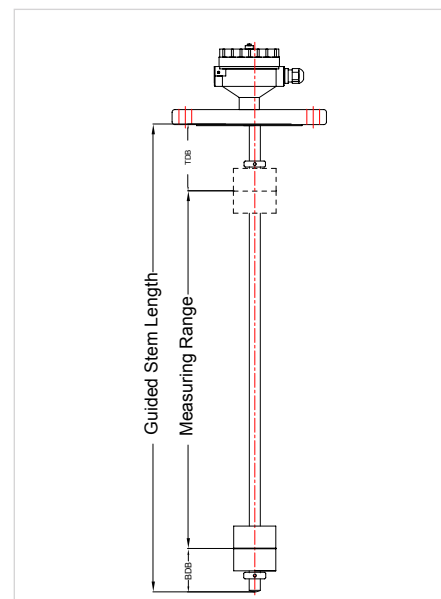
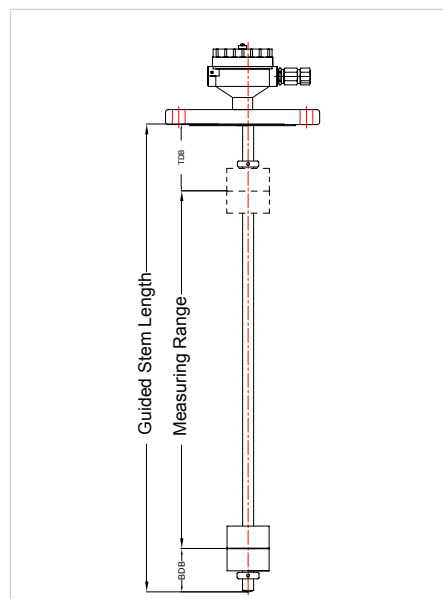

Type	FLX B-D-S2-A-1-1	FLX A-D-S2-A-1-1
Material Type	304 / 316 / 316L	304/316/316L
Enclosure	Cast Al, Ex-Proof Gr IIA, IIB or IIC	Cast Al, Weather Proof
Process Connection	2" Table 'E'	2" Table 'E'
Guide Stem	∅ 16 mm	∅ 16 mm
Sensor Length	MR = Min 300mm to 3750 mm * GSL= Min 375mm to 4000 mm *	MR = Min 300mm to 3750 mm * GSL= Min 375mm to 4000 mm *
Float	∅ 63 mm	∅ 63 mm
Specific Gravity	0.7	0.7
Design Pressure	10 Kg/cm ²	10 Kg/cm ²
Design Temperature	120°C	120°C
Output	4-20 mA	4-20 mA
Ingress protection Class	IP 65 (Flame Proof)	IP 65 (Weather Proof)
Mounting Position	Vertical	Vertical

Approval certificate

ATEX/CE/ABS

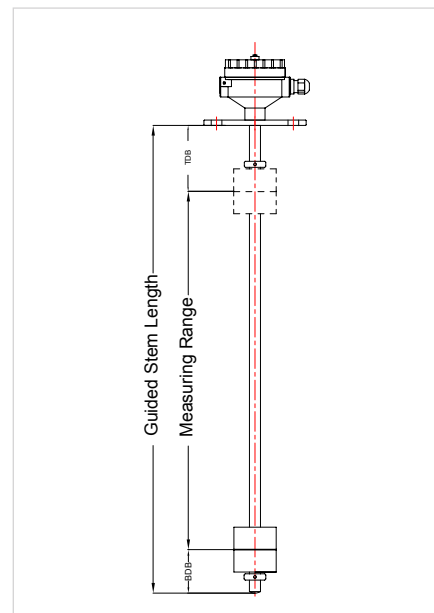
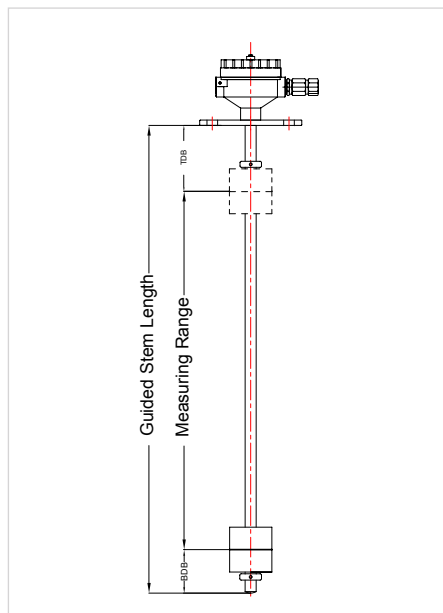

Type	FLX B-D-S2-A-1-1	FLX A-D-S2-A-1-1
Material Type	304 / 316 / 316L	304/316/316L
Enclosure	Cast Al, Ex-Proof Gr IIA, IIB or IIC	Cast Al, Weather Proof
Process Connection	2½" Table 'E'	2½" Table 'E'
Guide Stem	∅ 16 mm	∅ 16 mm
Sensor Length	MR = Min 300mm to 3750 mm * GSL= Min 375mm to 4000 mm *	MR = Min 300mm to 3750 mm * GSL= Min 375mm to 4000 mm *
Float	∅ 63 mm	∅ 63 mm
Specific Gravity	0.7	0.7
Design Pressure	10 Kg/cm ²	10 Kg/cm ²
Design Temperature	120°C	120°C
Output	4-20 mA	4-20 mA
Ingress protection Class	IP 65 (Flame Proof)	IP 65 (Weather Proof)
Mounting Position	Vertical	Vertical

Approval certificate

ATEX/CE/ABS

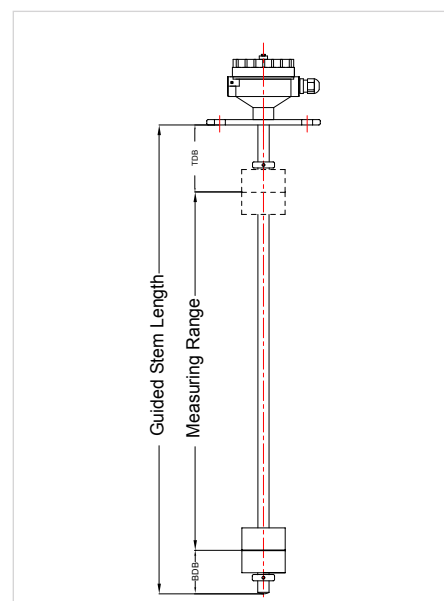
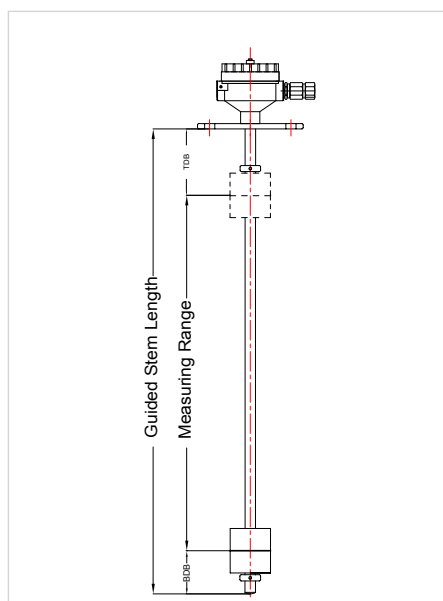

Type	FLX B-D-S2-D-1-1	FLX A-D-S2-D-1-1
Material Type	304 / 316 / 316L	304/316/316L
Enclosure	Cast Al, Ex-Proof Gr IIA, IIB or IIC	Cast Al, Weather Proof
Process Connection	3" Table 'E'	3" Table 'E'
Guide Stem	∅ 16 mm	∅ 16 mm
Sensor Length	MR = Min 300mm to 3750 mm * GSL= Min 375mm to 4000 mm *	MR = Min 300mm to 3750 mm * GSL= Min 375mm to 4000 mm *
Float	∅ 63 mm	∅ 63 mm
Specific Gravity	0.7	0.7
Design Pressure	10 Kg/cm ²	10 Kg/cm ²
Design Temperature	120°C	120°C
Output	1-5V DC	1-5V DC
Ingress protection Class	IP 65 (Flame Proof)	IP 65 (Weather Proof)
Mounting Position	Vertical	Vertical

Approval certificate

ATEX/CE/ABS

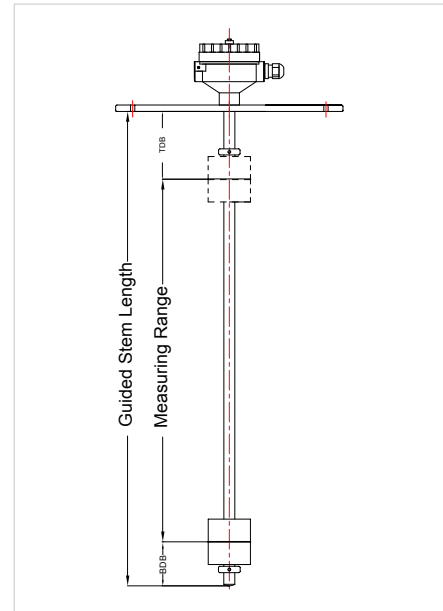
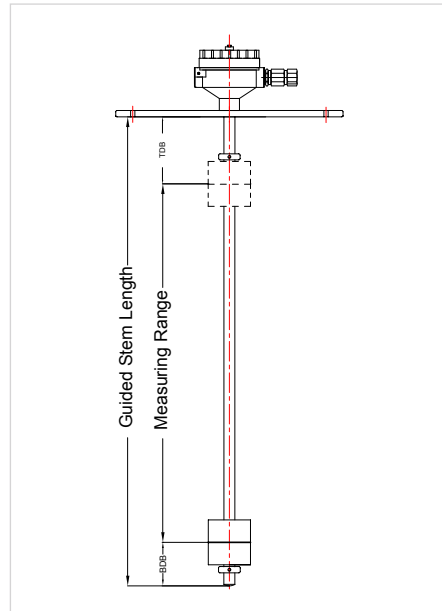

Type	FLX B-D-S2-A-1-1	FLX A-D-S2-A-1-1
Material Type	304 / 316 / 316L	304/316/316L
Enclosure	Cast Al, Ex-Proof Gr IIA, IIB or IIC	Cast Al, Weather Proof
Process Connection	DN 50 PN40	DN 50 PN40
Guide Stem	∅ 16 mm	∅ 16 mm
Sensor Length	MR = Min 300mm to 3750 mm * GSL= Min 375mm to 4000 mm *	MR = Min 300mm to 3750 mm * GSL= Min 375mm to 4000 mm *
Float	∅ 63 mm	∅ 63 mm
Specific Gravity	0.7	0.7
Design Pressure	10 Kg/cm ²	10 Kg/cm ²
Design Temperature	120°C	120°C
Output	4-20 mA	4-20 mA
Ingress protection Class	IP 65 (Flame Proof)	IP 65 (Weather Proof)
Mounting Position	Vertical	Vertical

Approval certificate

ATEX/CE/ABS

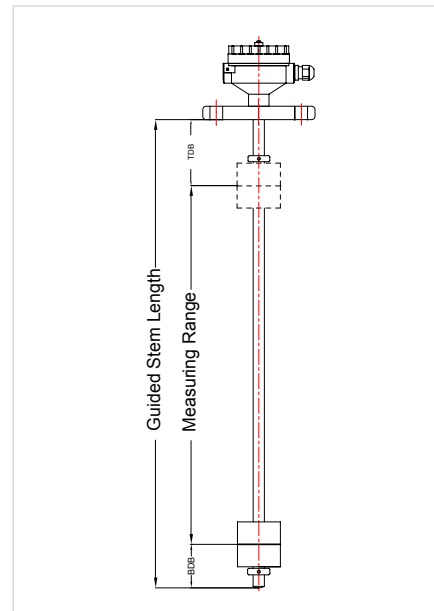
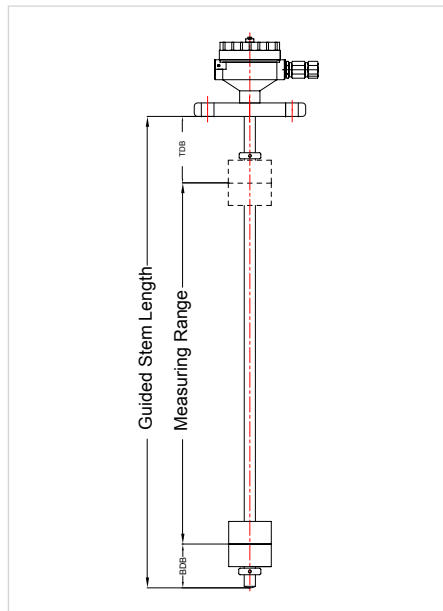

Type	FLX B-D-S2-D-1-1	FLX A-D-S2-D-1-1
Material Type	304 / 316 / 316L	304/316/316L
Enclosure	Cast Al, Ex-Proof Gr IIA, IIB or IIC	Cast Al, Weather Proof
Process Connection	DN 65 PN40	DN 65 PN40
Guide Stem	∅ 16 mm	∅ 16 mm
Sensor Length	MR = Min 300mm to 3750 mm * GSL= Min 375mm to 4000 mm *	MR = Min 300mm to 3750 mm * GSL= Min 375mm to 4000 mm *
Float	∅ 63 mm	∅ 63 mm
Specific Gravity	0.7	0.7
Design Pressure	10 Kg/cm ²	10 Kg/cm ²
Design Temperature	120°C	120°C
Output	1-5V DC	1-5V DC
Ingress protection Class	IP 65 (Flame Proof)	IP 65 (Weather Proof)
Mounting Position	Vertical	Vertical

Approval certificate

ATEX/CE/ABS

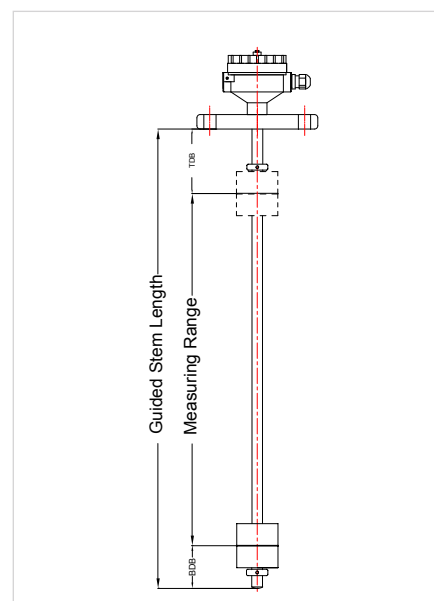
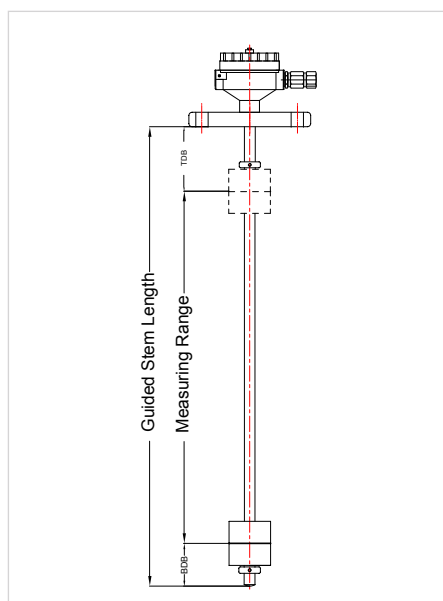

Type	FLX B-D-S2-A-1-1	FLX A-D-S2-A-1-1
Material Type	304 / 316 / 316L	304/316/316L
Enclosure	Cast Al, Ex-Proof Gr IIA, IIB or IIC	Cast Al, Weather Proof
Process Connection	DN 80 PN40	DN 80 PN40
Guide Stem	∅ 16 mm	∅ 16 mm
Sensor Length	MR = Min 300mm to 3750 mm * GSL= Min 375mm to 4000 mm *	MR = Min 300mm to 3750 mm * GSL= Min 375mm to 4000 mm *
Float	∅ 63 mm	∅ 63 mm
Specific Gravity	0.7	0.7
Design Pressure	10 Kg/cm ²	10 Kg/cm ²
Design Temperature	120°C	120°C
Output	4-20 mA	4-20 mA
Ingress protection Class	IP 65 (Flame Proof)	IP 65 (Weather Proof)
Mounting Position	Vertical	Vertical

Approval certificate

ATEX/CE/ABS

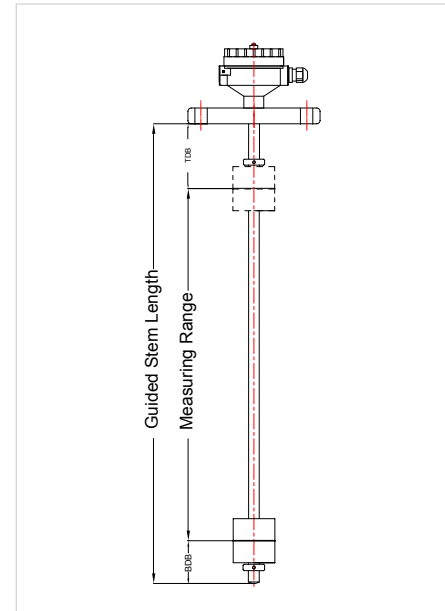
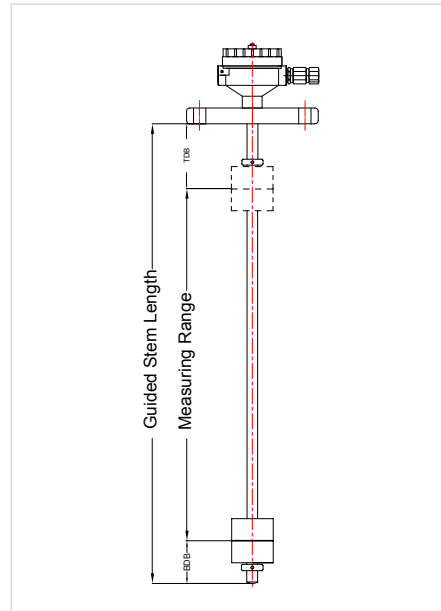

Type	FLX B-D-S2-D-1-1	FLX A-D-S2-D-1-1
Material Type	304 / 316 / 316L	304/316/316L
Enclosure	Cast Al, Ex-Proof Gr IIA, IIB or IIC	Cast Al, Weather Proof
Process Connection	DN 100 PN40	DN 100 PN40
Guide Stem	∅ 16 mm	∅ 16 mm
Sensor Length	MR = Min 300mm to 3750 mm * GSL= Min 375mm to 4000 mm *	MR = Min 300mm to 3750 mm * GSL= Min 375mm to 4000 mm *
Float	∅ 63 mm	∅ 63 mm
Specific Gravity	0.7	0.7
Design Pressure	10 Kg/cm ²	10 Kg/cm ²
Design Temperature	120°C	120°C
Output	1-5V DC	1-5V DC
Ingress protection Class	IP 65 (Flame Proof)	IP 65 (Weather Proof)
Mounting Position	Vertical	Vertical

Approval certificate

ATEX/CE/ABS

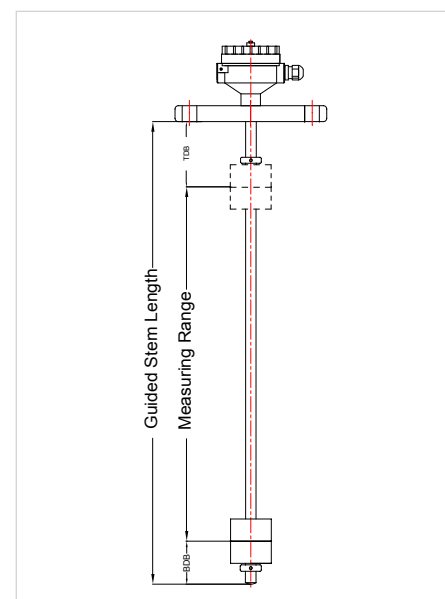
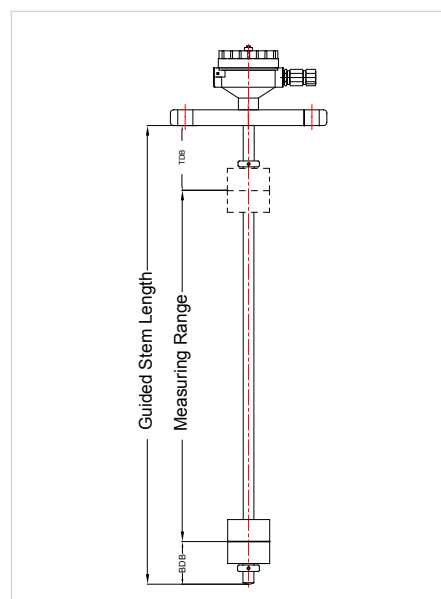

Type	FLX B-A-S1-A-2-1	FLX B-A-S2-D-2-1
Material Type	304 / 316 / 316L	304/316/316L
Enclosure	Cast Al, Ex-Proof Gr IIA, IIB or IIC	Cast Al, Ex-Proof Gr IIA, IIB or IIC
Process Connection	2" 150 # ANSI Flange	2" 150 # ANSI Flange
Guide Stem	∅ 12.7 mm	∅ 16 mm
Sensor Length	MR = Min 300mm to 3750 mm * GSL= Min 375mm to 4000 mm *	MR = Min 300mm to 3750 mm * GSL= Min 375mm to 4000 mm *
Float	∅ 52 mm	∅ 63 mm
Specific Gravity	0.7	0.7
Design Pressure	10 Kg/cm ²	10 Kg/cm ²
Design Temperature	120°C	120°C
Output	4-20 mA	1-5V DC
Ingress protection Class	IP 65 (Flame Proof)	IP 65 (Weather Proof)
Mounting Position	Horizontal	Horizontal

Approval certificate

ATEX/CE/ABS

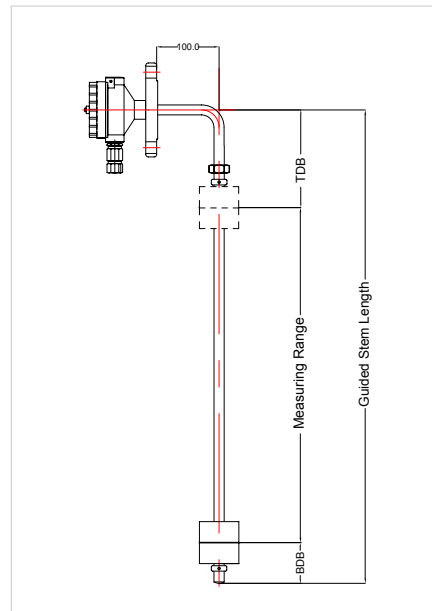
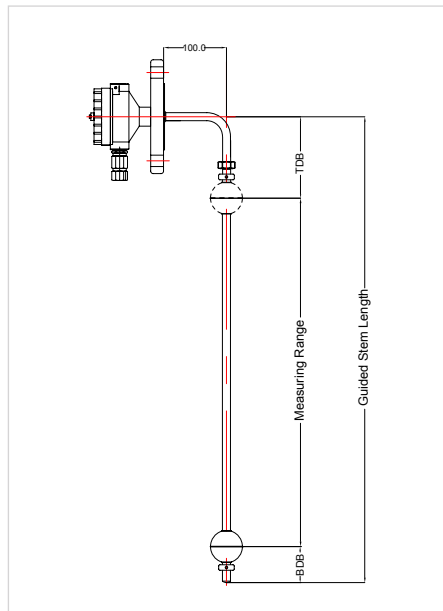

Type	FLX B-1-S1-A-2-1	FLX B-1-S2-D-2-1
Material Type	304 / 316 / 316L	304/316/316L
Enclosure	Cast Al, Ex-Proof Gr IIA, IIB or IIC	Cast Al, Ex-Proof Gr IIA, IIB or IIC
Process Connection	2" BSP Thread	2" BSP Thread
Guide Stem	∅ 12.7 mm	∅ 16 mm
Sensor Length	MR = Min 300mm to 3750 mm * GSL= Min 375mm to 4000 mm *	MR = Min 300mm to 3750 mm * GSL= Min 375mm to 4000 mm *
Float	∅ 52 mm	∅ 63 mm
Specific Gravity	0.7	0.7
Design Pressure	10 Kg/cm ²	10 Kg/cm ²
Design Temperature	120°C	120°C
Output	4-20 mA	1-5V DC
Ingress protection Class	IP 65 (Flame Proof)	IP 65 (Weather Proof)
Mounting Position	Horizontal	Horizontal

Approval certificate

ATEX/CE/ABS

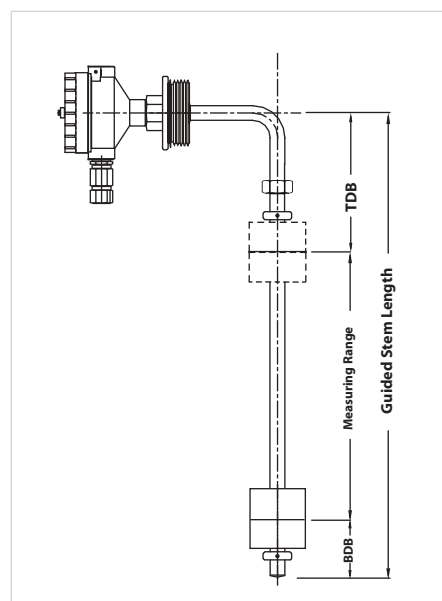
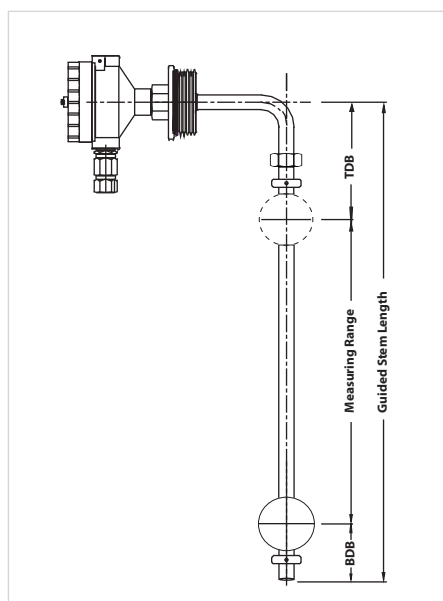

Type	FLX B-1-S1-A-1-1	FLX B-3-S1-A-1-1
Material Type	304 / 316 / 316L	304/316/316L
Enclosure	Cast Al, Ex-Proof Gr IIA, IIB or IIC	Cast Al, Ex-Proof Gr IIA, IIB or IIC
Process Connection	2" BSP Thread	2 1/2" BSP Thread
Guide Stem	∅ 12.7 mm	∅ 12.7 mm
Sensor Length	MR = Min 300mm to 3750 mm * GSL= Min 375mm to 4000 mm *	MR = Min 300mm to 3750 mm * GSL= Min 375mm to 4000 mm *
Float	∅ 52 mm	∅ 52 mm
Specific Gravity	0.7	0.7
Design Pressure	10 Kg/cm ²	10 Kg/cm ²
Design Temperature	120°C	120°C
Output	4-20 mA	4-20 mA
Ingress protection Class	IP 65 (Flame Proof)	IP 65 (Weather Proof)
Mounting Position	Vertical	Vertical

Approval certificate

ATEX/CE/ABS

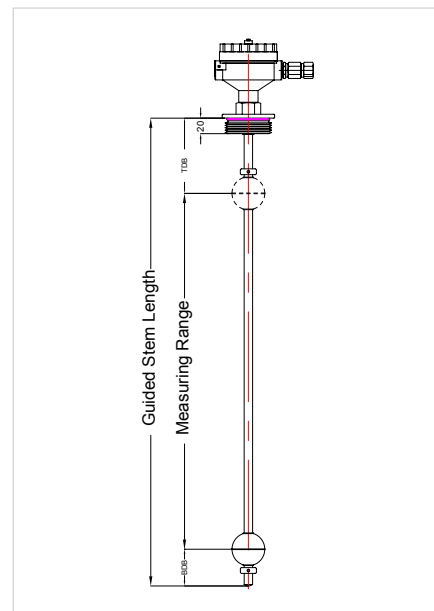
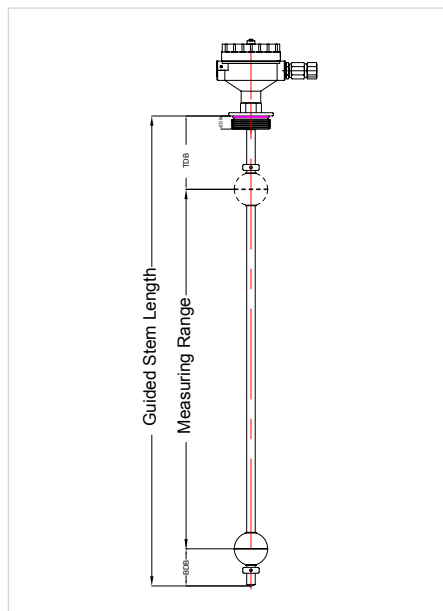

Type	FLX B-2-S1-D-1-1	FLX B-3-S1-D-1-1
Material Type	304 / 316 / 316L	304/316/316L
Enclosure	Cast Al, Ex-Proof Gr IIA, IIB or IIC	Cast Al, Ex-Proof Gr IIA, IIB or IIC
Process Connection	3" BSP Thread	4" BSP Thread
Guide Stem	∅ 12.7 mm	∅ 12.7 mm
Sensor Length	MR = Min 300mm to 3750 mm * GSL= Min 375mm to 4000 mm *	MR = Min 300mm to 3750 mm * GSL= Min 375mm to 4000 mm *
Float	∅ 52 mm	∅ 52 mm
Specific Gravity	0.7	0.7
Design Pressure	10 Kg/cm ²	10 Kg/cm ²
Design Temperature	120°C	120°C
Output	1-5V DC	1-5V DC
Ingress protection Class	IP 65 (Flame Proof)	IP 65 (Weather Proof)
Mounting Position	Vertical	Vertical

Approval certificate

ATEX/CE/ABS

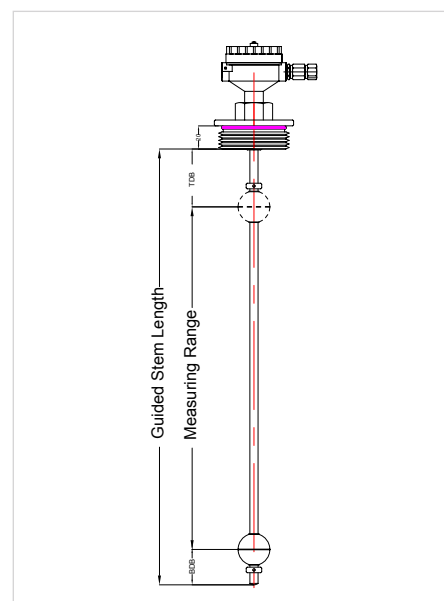
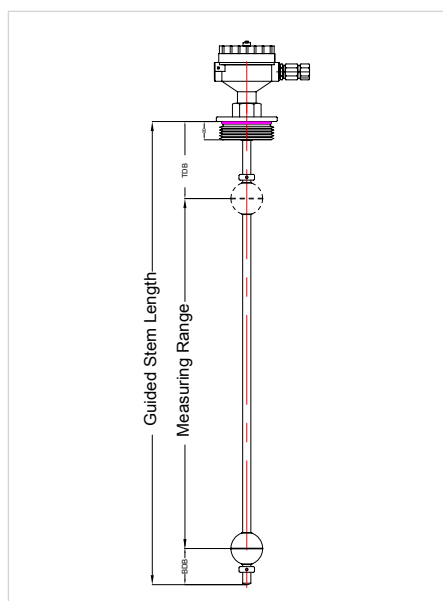

Type	FLX B-3-S2-A-1-1	FLX B-2-S2-A-1-1
Material Type	304 / 316 / 316L	304/316/316L
Enclosure	Cast Al, Ex-Proof Gr IIA, IIB or IIC	Cast Al, Weather Proof
Process Connection	2½" BSP Thread	3" BSP Thread
Guide Stem	∅ 16 mm	∅ 16 mm
Sensor Length	MR = Min 300mm to 3750 mm * GSL= Min 375mm to 4000 mm *	MR = Min 300mm to 3750 mm * GSL= Min 375mm to 4000 mm *
Float	∅ 63 mm	∅ 63 mm
Specific Gravity	0.7	0.7
Design Pressure	10 Kg/cm ²	10 Kg/cm ²
Design Temperature	120°C	120°C
Output	4-20 mA	4-20 mA
Ingress protection Class	IP 65 (Flame Proof)	IP 65 (Weather Proof)
Mounting Position	Vertical	Vertical

Approval certificate

ATEX/CE/ABS

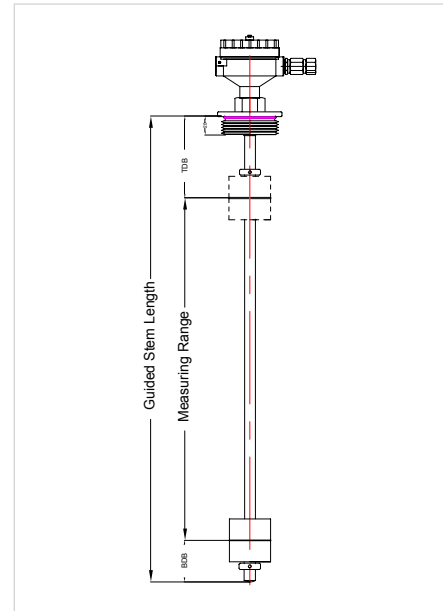
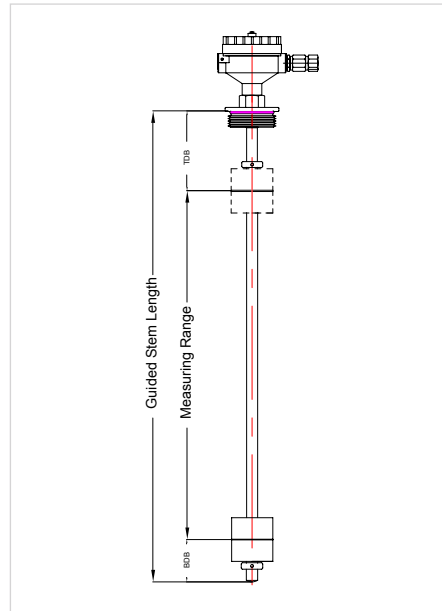

Type

Type	FLX A-3-S2-D-1-1
Material Type	304 / 316 / 316L
Enclosure	Cast Al, Ex-Proof Gr IIA, IIB or IIC
Process Connection	4" BSP Thread
Guide Stem	∅ 16 mm
Sensor Length	MR = Min 300mm to 3750 mm * GSL= Min 375mm to 4000 mm *
Float	∅ 63 mm
Specific Gravity	0.8
Design Pressure	10 Kg/cm ²
Design Temperature	120°C
Output	1-5V DC
Ingress protection Class	IP 65 (Weather Proof)
Mounting Position	Vertical

Approval certificate

ATEX/CE/ABS

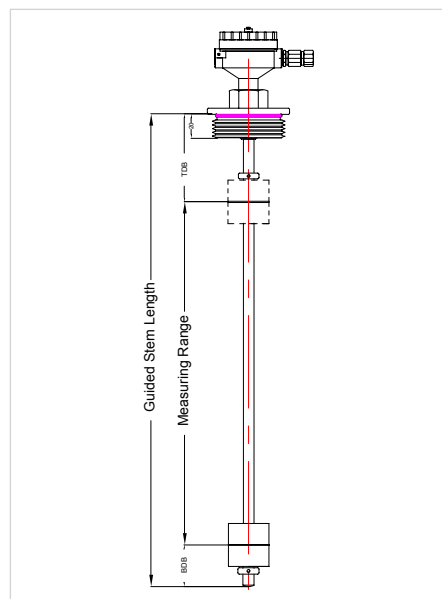

Type	FLX B-3-S2-A-1-1	FLX B-2-S2-A-1-1
Material Type	304 / 316 / 316L	304/316/316L
Enclosure	Cast Al, Ex-Proof Gr IIA, IIB or IIC	Cast Al, Ex-Proof Gr IIA, IIB or IIC
Process Connection	2½" NPT Thread	3" NPT Thread
Guide Stem	∅ 16 mm	∅ 16 mm
Sensor Length	MR = Min 300mm to 3750 mm * GSL= Min 375mm to 4000 mm *	MR = Min 300mm to 3750 mm * GSL= Min 375mm to 4000 mm *
Float	∅ 63 mm	∅ 63 mm
Specific Gravity	0.7	0.7
Design Pressure	10 Kg/cm ²	10 Kg/cm ²
Design Temperature	120°C	120°C
Output	4-20 mA	4-20 mA
Ingress protection Class	IP 65 (Flame Proof)	IP 65 (Weather Proof)
Mounting Position	Vertical	Vertical

Approval certificate
ATEX/CE/ABS

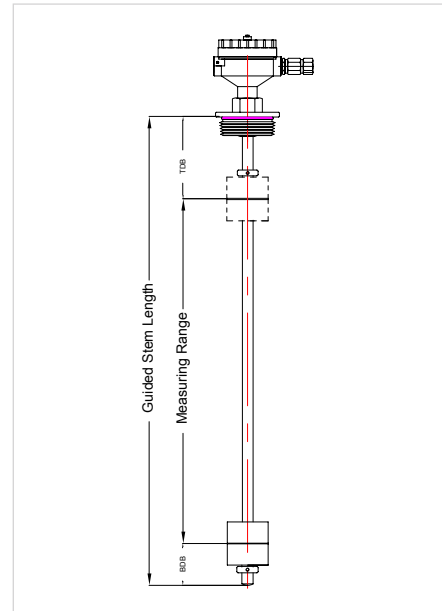
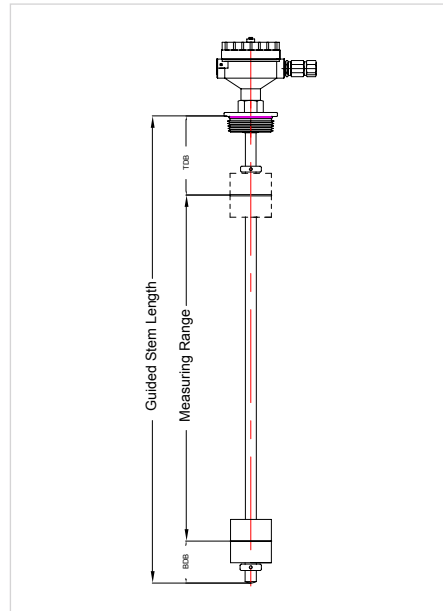

Type	FLX B-3-S2-D-1-1
Material Type	304 / 316 / 316L
Enclosure	Cast Al, Ex-Proof Gr IIA, IIB or IIC
Process Connection	4" NPT Thread
Guide Stem	∅ 16 mm
Sensor Length	MR = Min 300mm to 3750 mm * GSL= Min 375mm to 4000 mm *
Float	∅ 63 mm
Specific Gravity	0.8
Design Pressure	10 Kg/cm ²
Design Temperature	120°C
Output	1-5V DC
Ingress protection Class	IP 65 (Weather Proof)
Mounting Position	Vertical

Approval certificate
ATEX/CE/ABS

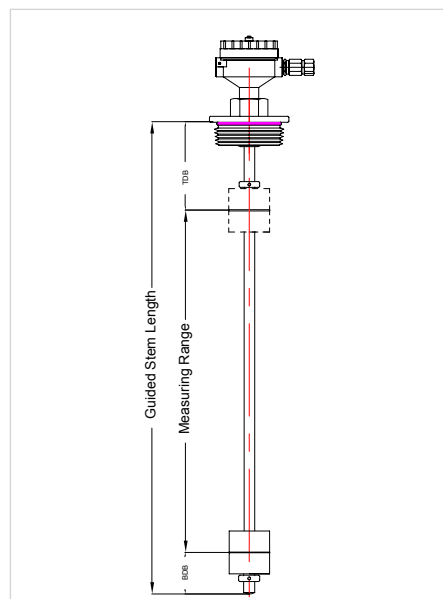

FLOAT LEVEL TRANSMITTER WITH FERRULE

Ferrule type is used in applications where in the Measuring Range is not fixed or if the vessel / tank dimensions are not clearly known. Ferrule enables us to adjust the measuring range to the desired level ($\pm 300\text{mm}$)

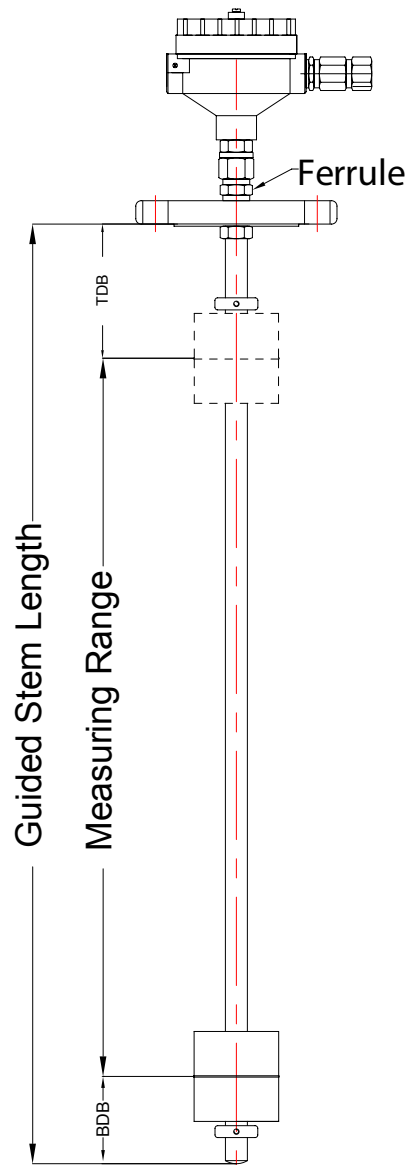

FLOAT LEVEL TRANSMITTER INSTALLED IN A CHAMBER

Wherever it is not possible or desirable to install Float Level Transmitter directly onto the vessel, switches can be installed in an External Chamber. This arrangement gives smooth level control irrespective of turbulence in the process vessel and prevents accidental damages to the switch during shutdown or maintenance of the vessel. Chambers are used in applications which require isolations of process, High Pressure / High Temperature applications, Corrosive applications, Onshore / Offshore installations.

Main function of these chambers are :

1. Level Measurement
2. Interface Measurement between two liquids.

FEATURES :

- Available for Low Pressure and High Pressure applications.
- Wide range of material of construction to suit different environmental conditions.
- Wide range of end connection types / sizes to choose from.
- A variety of chamber mounting arrangements provided to suit existing nozzles.

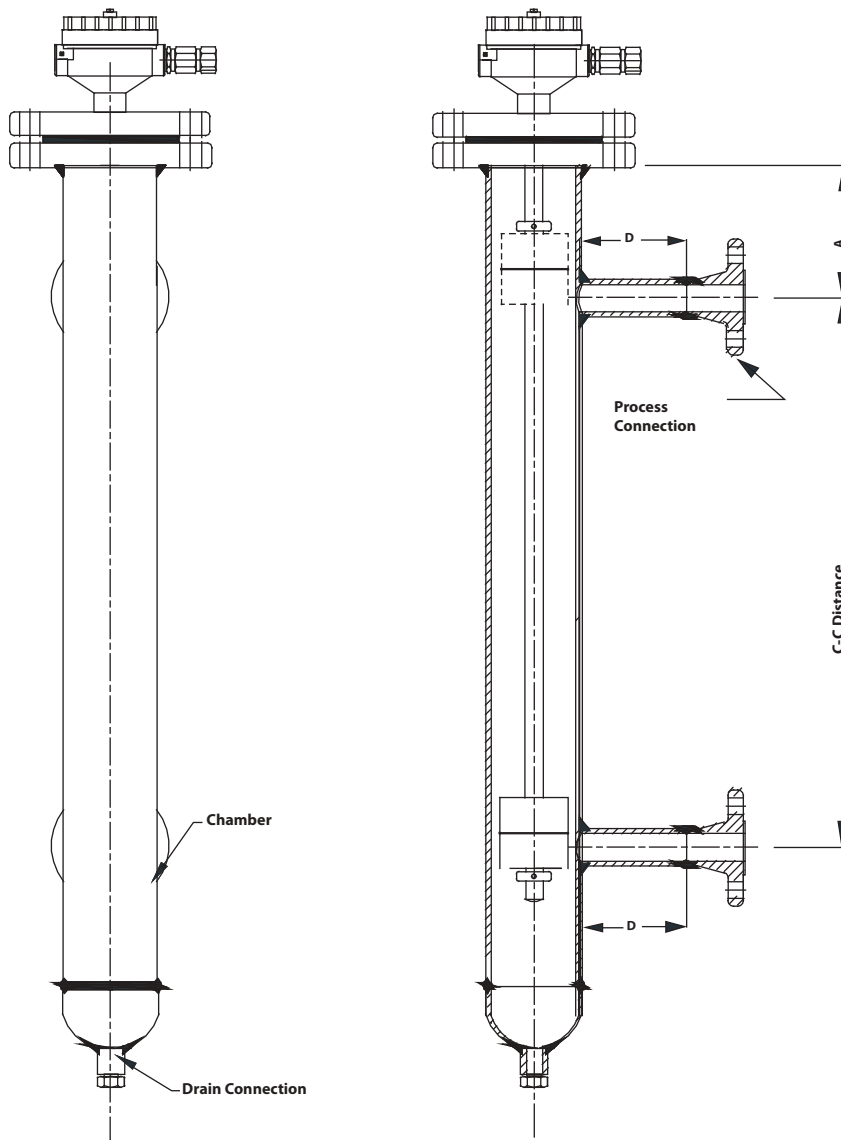

3. MLX SERIES - MAGNETOSTRICTIVE LEVEL TRANSMITTER

This high-precision and robust level transmitter is designed to provide continuous gauging of liquid media levels in tanks. The measuring principle used by the magnetic float level transmitter exploits the physical effect of magnetostriction and is largely unaffected by temperature. Magnetostriction is particularly ideal where level measurements are required to be extremely accurate, e.g. in the Petrochemical / Oil , Gas industry. The level sensor outputs measuring signals in the range of 4 to 20 mA. Available in lengths 200 to 4,000 mm, it is compatible with a variety of tank dimensions. It also comes in the following versions:
The explosion-proof version of the level sensor can be installed in potentially explosive atmospheres in which electrical equipment of category 1 (zone 0) or category 1/2 (zone 0/1) are required. Operating on the digital HART protocol, the HART level sensor is able to output the position of the first, second or both floats.



SPECIAL FEATURES

- Continuous level measurement on the outside of the bypass chamber / Inside Tank.
- 2-wire technology, 4mA to 20 mA.
- Measured value output via digital interface and a selectable measured value as analogue signal.
- Stainless steel Enclosure (Integral Digital display) – Optional.

3.1 APPLICATIONS

- Sensor for continuous level measurement of liquids in bypass level indicators.
- Chemical, petrochemical, off shore industries.
- Shipbuilding, machine building.
- Power generating equipment, power plants.
- Pharmaceutical, food, water treatment, environmental engineering industries.

3.2 OPERATING PRINCIPLE

Inside the probe tube there is a rigid wire made of magnetostrictive material. The sensor circuitry emits pulses of current through the wire, generating a circular magnetic field. The level transmitter is a magnet, which is integrated into the float. Its magnetic field magnetizes the wire axially. Since the two magnetic fields are superimposed, around the float magnet a torsion wave is generated which runs in both directions along the wire. One wave runs directly to the probe head while the other is reflected at the bottom of the probe tube. The time is measured between emission of the current pulse and arrival of the wave at the probe head. The position of the float is determined on the basis of the transit times.

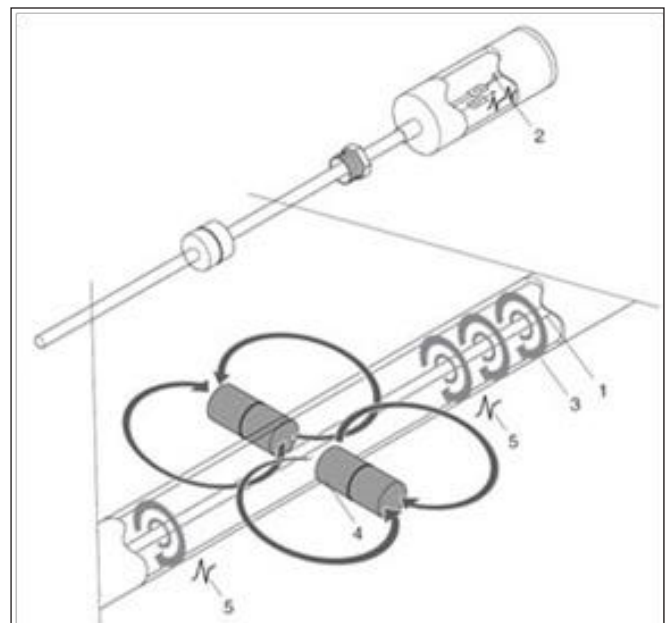



INDIA

HEAD OFFICE AND FACTORY

SHRIDHAN Automation Pvt. Ltd.

#B-54, KSSIDC Industrial Estate, Kumbalgodu , Mysore Road
Bangalore - 560074

INDIA

Phone: +91-80-28437847/+91-80-28437848

UNIT-2

SHRIDHAN Automation Pvt. Ltd.

D13, KIADB Industrial Area, Kumbalgodu, Mysore Road
Bangalore - 560074

INDIA

Email: info@shridhan.com

Website : www.shridhan.com

MIDDLE EAST

Orbit Automation FZE

#R4-40 A, PO Box - 122828

SAIF Zone, Sharjah

INDIA

(A 100% SUBSIDIARY OF SHRIDHAN Automation, INDIA)

Contact :+97155 - 9347963 / +97155 - 1883375

Email: me@shridhan.com

Indian Marketing Network

Mangalore | New Delhi | Ahmedabad | Pune | Mumbai | Chennai

International Marketing Network

Middle East | Singapore | Malaysia | Thailand | Netherlands | USA